

General Description

The AON3814 uses advanced trench technology to provide excellent $R_{DS(ON)}$, low gate charge and operation with gate voltages as low as 1.8V while retaining a 12V $V_{GS(MAX)}$ rating. It is ESD protected. This device is suitable for use as a uni-directional or bi-directional load switch, facilitated by its common-drain configuration.

Product Summary

| | |
|------------------------------------|------------------|
| V_{DS} | 20V |
| I_D (at $V_{GS}=4.5V$) | 6A |
| $R_{DS(ON)}$ (at $V_{GS} = 4.5V$) | < 17m Ω |
| $R_{DS(ON)}$ (at $V_{GS} = 4V$) | < 18.5m Ω |
| $R_{DS(ON)}$ (at $V_{GS} = 3.1V$) | < 23m Ω |
| $R_{DS(ON)}$ (at $V_{GS} = 2.5V$) | < 24m Ω |

ESD Protected

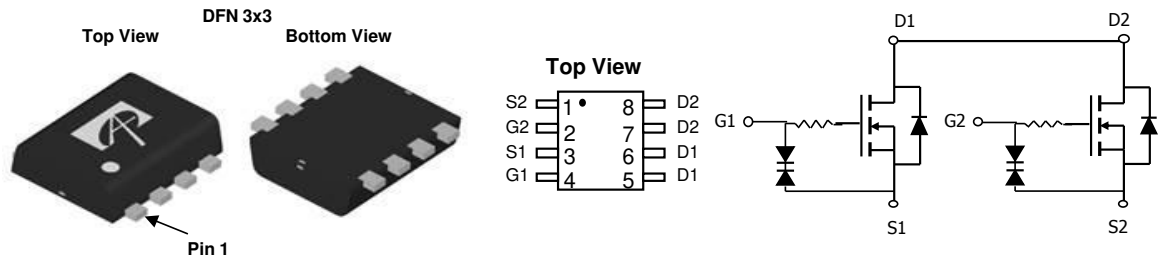

Absolute Maximum Ratings $T_A=25^\circ C$ unless otherwise noted

| Parameter | Symbol | Maximum | Units |
|--|----------------|------------------|------------|
| Drain-Source Voltage | V_{DS} | 20 | V |
| Gate-Source Voltage | V_{GS} | ± 12 | V |
| Continuous Drain Current ^F | I_D | $T_C=25^\circ C$ | 6 |
| | | $T_C=70^\circ C$ | 5.3 |
| Pulsed Drain Current ^B | I_{DM} | 40 | A |
| Power Dissipation ^F | P_D | $T_C=25^\circ C$ | 2.5 |
| | | $T_C=70^\circ C$ | 1.6 |
| Junction and Storage Temperature Range | T_J, T_{STG} | -55 to 150 | $^\circ C$ |

Thermal Characteristics

| Parameter | Symbol | Typ | Max | Units |
|--|-----------------|--------------|-----|--------------|
| Maximum Junction-to-Ambient ^A | $R_{\theta JA}$ | 40 | 50 | $^\circ C/W$ |
| Maximum Junction-to-Ambient ^A | | Steady-State | 75 | 95 |
| Maximum Junction-to-Lead ^C | $R_{\theta JL}$ | 30 | 40 | $^\circ C/W$ |

Electrical Characteristics (T_J=25°C unless otherwise noted)

| Symbol | Parameter | Conditions | Min | Typ | Max | Units |
|-----------------------------|---------------------------------------|--|-----|--------------|----------|-------|
| STATIC PARAMETERS | | | | | | |
| BV _{DSS} | Drain-Source Breakdown Voltage | I _D =250μA, V _{GS} =0V | 20 | | | V |
| I _{DSS} | Zero Gate Voltage Drain Current | V _{DS} =20V, V _{GS} =0V T _J =55°C | | | 1 5 | μA |
| I _{GSS} | Gate-Body leakage current | V _{DS} =0V, V _{GS} = ±10V | | | 10 | μA |
| V _{GS(th)} | Gate Threshold Voltage | V _{DS} =V _{GS} I _D =250μA | 0.3 | 0.7 | 1.1 | V |
| I _{D(ON)} | On state drain current | V _{GS} =4.5V, V _{DS} =5V | 40 | | | A |
| R _{DS(ON)} | Static Drain-Source On-Resistance | V _{GS} =4.5V, I _D =6A T _J =125°C | | 12.5 18.5 | 17 24 | mΩ |
| | | V _{GS} =4V, I _D =6A | | 12.9 | 18.5 | mΩ |
| | | V _{GS} =3.1V, I _D =6A | | 14 | 23 | mΩ |
| | | V _{GS} =2.5V, I _D =6A | | 15.6 | 24 | mΩ |
| | | V _{GS} =1.8V, I _D =6A | | 23 | | mΩ |
| g _{FS} | Forward Transconductance | V _{DS} =5V, I _D =6A | | 33 | | S |
| V _{SD} | Diode Forward Voltage | I _S =1A, V _{GS} =0V | | 0.6 | 1 | V |
| I _S | Maximum Body-Diode Continuous Current | | | | 3.5 | A |
| DYNAMIC PARAMETERS | | | | | | |
| C _{iss} | Input Capacitance | V _{GS} =0V, V _{DS} =10V, f=1MHz | 730 | 920 | 1100 | pF |
| C _{oss} | Output Capacitance | | 110 | 155 | 200 | pF |
| C _{rss} | Reverse Transfer Capacitance | | 45 | 75 | 105 | pF |
| R _g | Gate resistance | V _{GS} =0V, V _{DS} =0V, f=1MHz | | 2.4 | | kΩ |
| SWITCHING PARAMETERS | | | | | | |
| Q _g | Total Gate Charge | V _{GS} =4.5V, V _{DS} =10V, I _D =6A | 8.8 | 11 | 13 | nC |
| Q _{gs} | Gate Source Charge | | 1.6 | 2 | 2.4 | nC |
| Q _{gd} | Gate Drain Charge | | 1.9 | 3.2 | 4.5 | nC |
| t _{D(on)} | Turn-On DelayTime | V _{GS} =5V, V _{DS} =10V, R _L =1.7Ω, R _{GEN} =3Ω | | 0.3 | | μs |
| t _r | Turn-On Rise Time | | | 0.6 | | μs |
| t _{D(off)} | Turn-Off DelayTime | | | 7.9 | | μs |
| t _f | Turn-Off Fall Time | | | 4.4 | | μs |

A. The value of R_{θJA} is measured with the device mounted on 1in² FR-4 board with 2oz. Copper, in a still air environment with T_A =25° C. The value in any given application depends on the user's specific board design.

B. The power dissipation P_D is based on T_{J(MAX)}=150° C, using ≤ 10s junction-to-ambient thermal resistance.

C. Repetitive rating, pulse width limited by junction temperature T_{J(MAX)}=150° C. Ratings are based on low frequency and duty cycles to keep initial T_J=25° C.

D. The R_{θJA} is the sum of the thermal impedance from junction to lead R_{θJL} and lead to ambient.

E. The static characteristics in Figures 1 to 6 are obtained using <300μs pulses, duty cycle 0.5% max.

F. These curves are based on the junction-to-ambient thermal impedance which is measured with the device mounted on 1in² FR-4 board with 2oz. Copper, assuming a maximum junction temperature of T_{J(MAX)}=150° C. The SOA curve provides a single pulse rating.

APPLICATIONS OR USE AS CRITICAL COMPONENTS IN LIFE SUPPORT DEVICES OR SYSTEMS ARE NOT AUTHORIZED. AOS DOES NOT ASSUME ANY LIABILITY ARISING OUT OF SUCH APPLICATIONS OR USES OF ITS PRODUCTS. AOS RESERVES THE RIGHT TO IMPROVE PRODUCT DESIGN,FUNCTIONS AND RELIABILITY WITHOUT NOTICE.

TYPICAL ELECTRICAL AND THERMAL CHARACTERISTICS

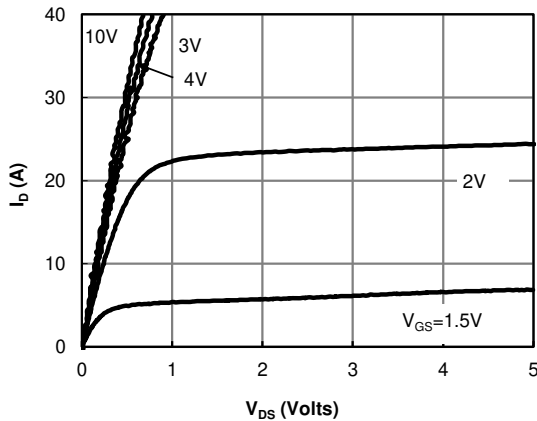

Fig 1: On-Region Characteristics (Note E)

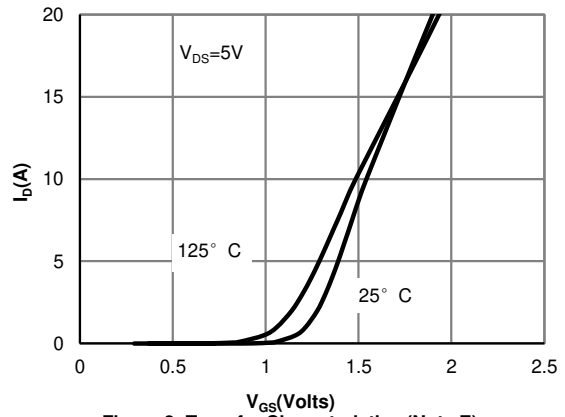

Figure 2: Transfer Characteristics (Note E)

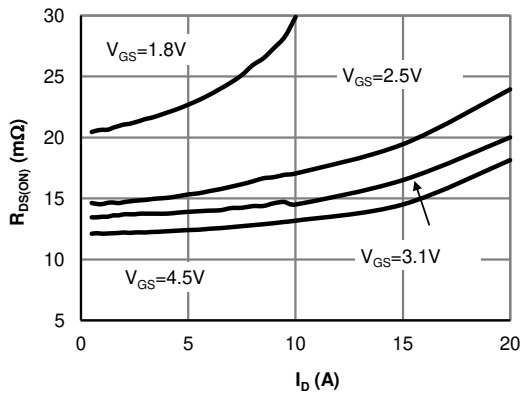

Figure 3: On-Resistance vs. Drain Current and Gate Voltage (Note E)

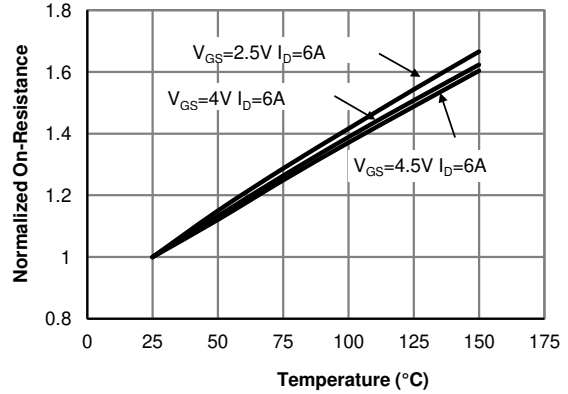

Figure 4: On-Resistance vs. Junction Temperature (Note E)

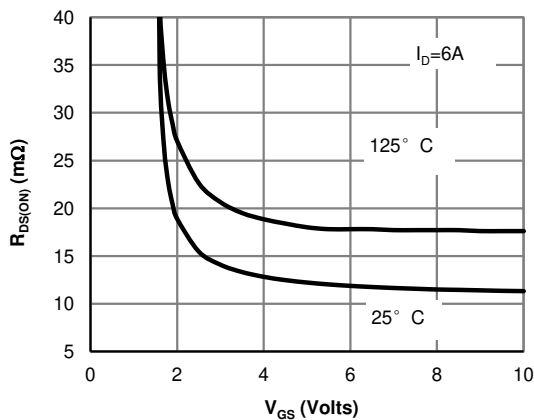

Figure 5: On-Resistance vs. Gate-Source Voltage (Note E)

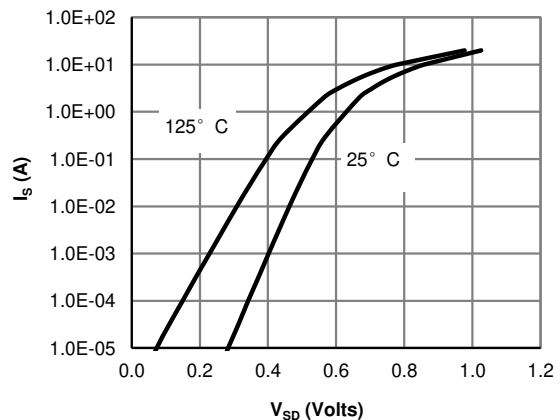

Figure 6: Body-Diode Characteristics (Note E)

TYPICAL ELECTRICAL AND THERMAL CHARACTERISTICS

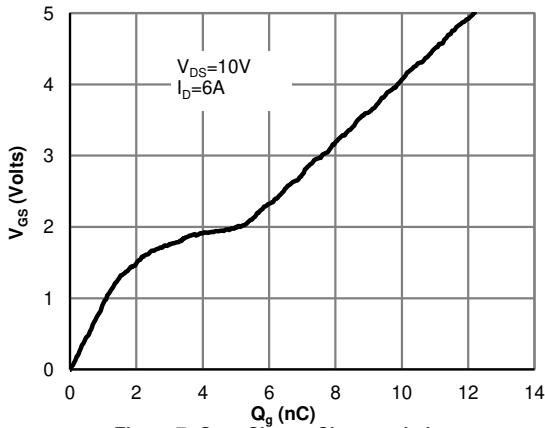

Figure 7: Gate-Charge Characteristics

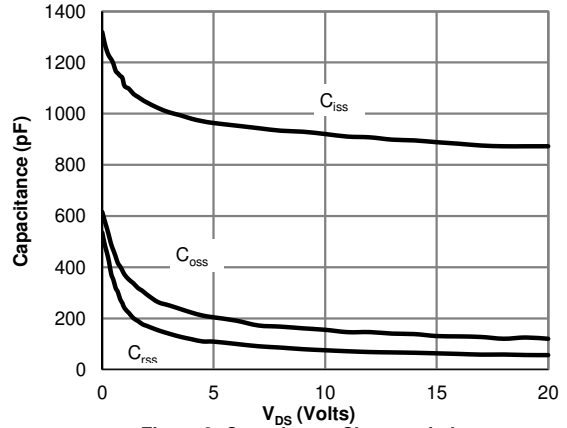

Figure 8: Capacitance Characteristics

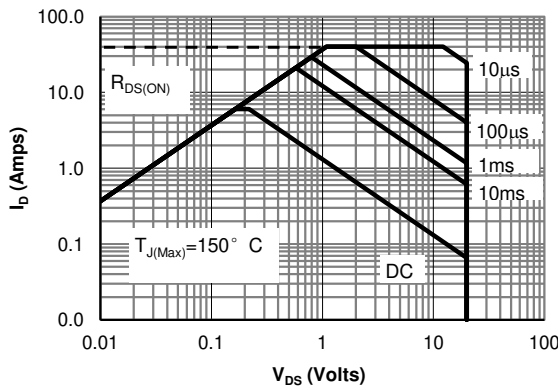

Figure 9: Maximum Forward Biased Safe Operating Area (Note F)

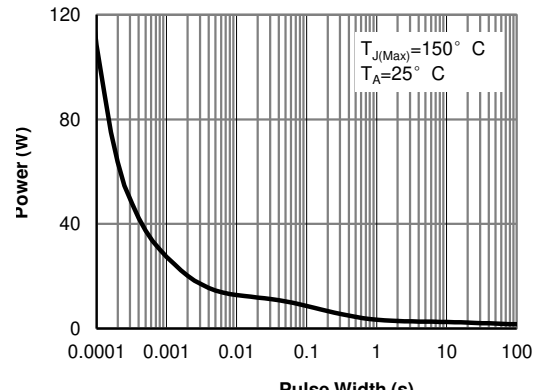

Figure 10: Single Pulse Power Rating Junction-to-Case (Note F)

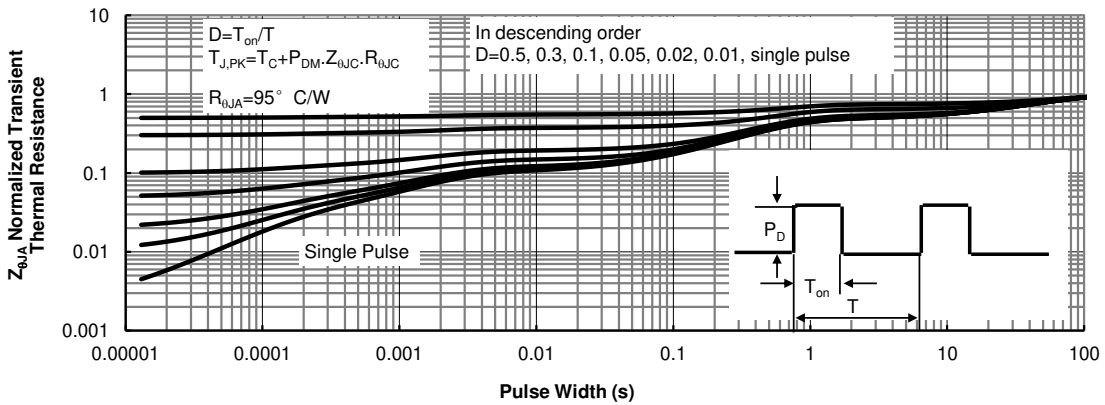
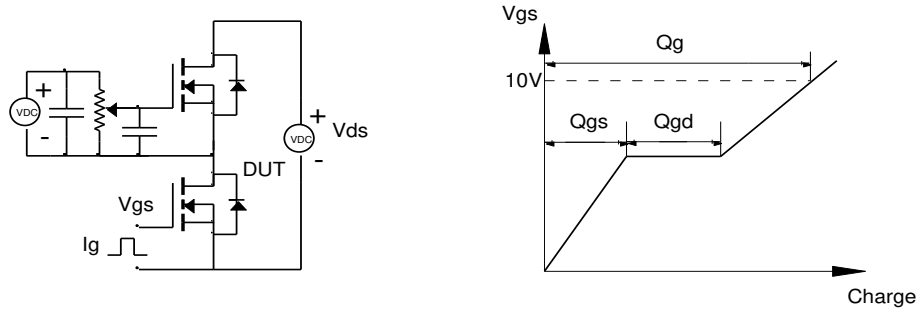
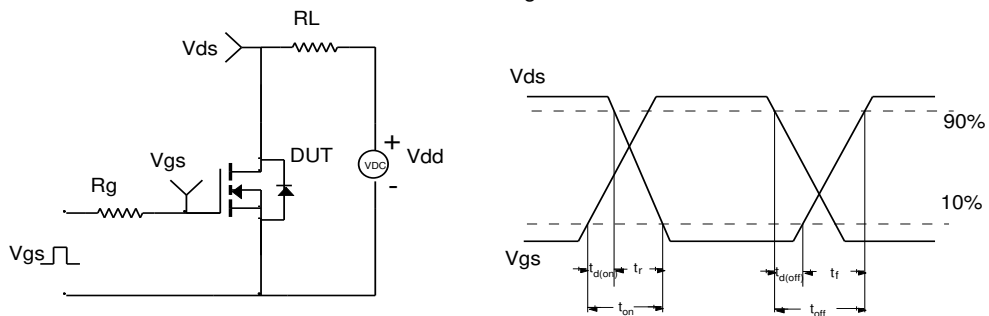

Figure 11: Normalized Maximum Transient Thermal Impedance (Note F)

Gate Charge Test Circuit & Waveform



Resistive Switching Test Circuit & Waveforms



Unclamped Inductive Switching (UIS) Test Circuit & Waveforms

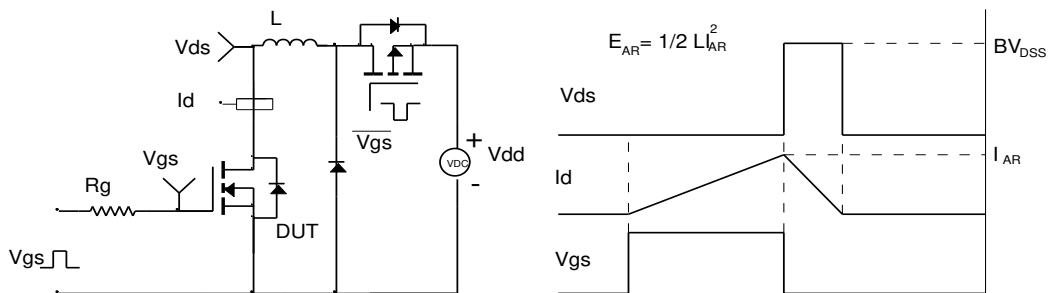

Diode Recovery Test Circuit & Waveforms

